

Elettromandrino / Electrospindle:
QN1F 6/18 24 ER32 DX
Codice/Code:
QN.200.A07.02

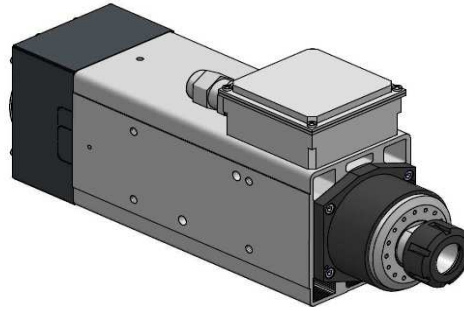

Prestazioni / Performances

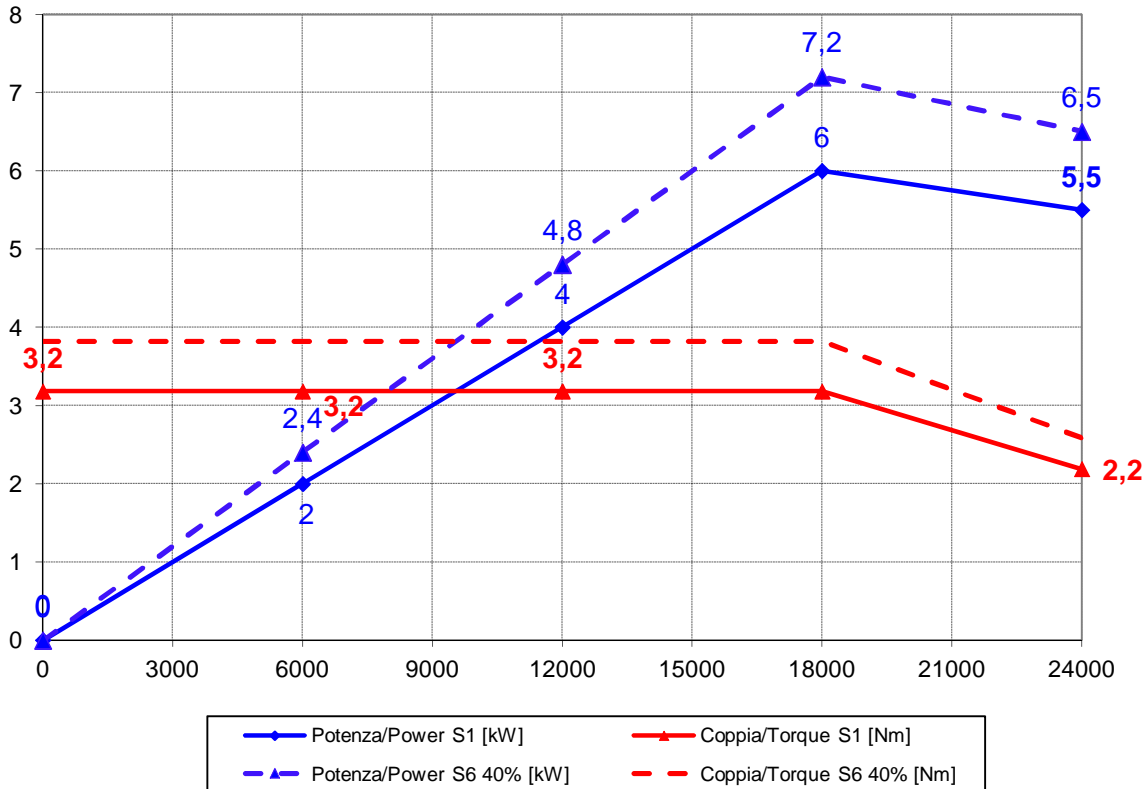

Specifiche tecniche / Technical specifications	
Potenza max. (S1) / Max. Power.(S1 duty)	6 kW @ 18000 rpm
Coppia max. (S1) / Max. Torque (S1 duty)	3,2 Nm
Velocità max. / Max. speed	24000 rpm
Numero di poli / Poles	2
Tensione / Voltage	380 V
Corrente nom. / Current	12,5
Rotazione / Rotation	CW
Azionamento / Supply	con inverter / by inverter
Attacco / Tool interface	ER32 DX
Cuscinetti Anteriori / Frontal ball bearings	Obliqui ad alta velocità alta precisione / High speed high precision angular contact ball bearings
Raffreddamento / Cooling	elettroventola 24V DC / air by electric fan 24V DC
Peso / Weight	15 kg